

SPECIFICATION FOR APPROVAL

CUSTOMER :
 CUSTOMER P/N :
 ELIVEN P/N : TSPI-0412 series
 DESCRIPTION : SMD INDUCTOR
 APPLICATION : NON-AUTOMOTIVE
 ISSUED DATE : 2020-04-30
 RELEASE NOTE :

APPROVAL FEEDBACK		
REMARK:		

Maker

信華株式會社

SINKA JAPAN Co., Ltd
 SUMITO LIFE Gotanda BLG 5F, 5-1-110
 Osaki, Shinagawa Ward, Tokyo, Japan
 TEL: +81 3 3591 5320 FAX: +81 3 3491 5320

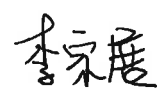
APPROVED	CHECKED	RECEIVED
今井禎宏		



A Features

- Low profile: Thickness 1.2 mm MAX
- Low loss with low DCR designs
- High performance (Isat) with low noise
- High operating frequency (up to 1MHz)
- RoHS and HF compliance

B Applications

- DC to DC conversion circuit
- VRM for consumer or commercial application
- Laptop/personal computing application

C Dimensions

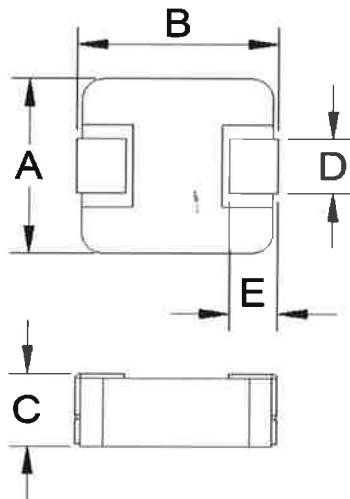

Dimensions	
A	4.2 ± 0.25
B	4.4 ± 0.25
C	1.0 ± 0.2
D	1.5 ± 0.3
E	0.8 ± 0.3

Unit : mm

D Recommended Land Pattern

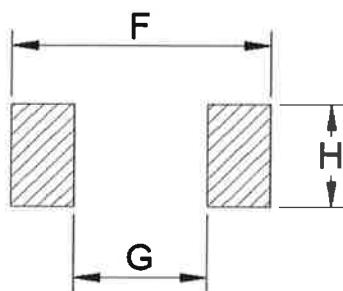

Dimensions	
F	4.95
G	2.15
H	2.3

Unit : mm

E Schematics

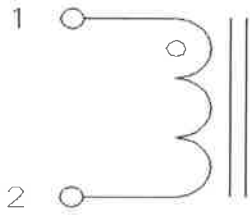

F Marking Demostration

(F1) Marking

The inductance is coded and marked by 3 digits

Where -> 1.0 μ H -> 1R0

(F2) Orientation of Marking

"Horizontal alignment" to the parts, as shown in below:



G Part Number and Demostrations :

TSPI - 0412 - 1R0 M
 (G1) (G2) (G3) (G4) (G5)

(G1) Series Code

Unique identification code(s) for each series of product

(G2) Size Code

0402 = 4 x 4 x 1.2 ([mm] ref.)

(G3) Inductance Code

R10 > 0.1 μ H // 1R0 > 1.0 μ H // 100 > 10 μ H // 101 > 100 μ H

(G4) Tolerance Code

J > \pm 5% // K > \pm 10% // M > \pm 20% // N > \pm 30%

(G5) Reserved Code for futher use

H Electrical Characteristics

P/N	SelfLead (SL) LeadFrame (LF)	L0	DC		Heat Rating	Saturation	N/W (g) (REF)
		Inductance	Resistance		Current	Current	
		$\mu\text{H} \pm 20\%$	Rdc (m Ω)		Idc (AMP)	Isat (AMP)	
		@0A	Typical	Max	Typical	Typical	
TSPI-0412-R33M	LF	0.33	17	19	6.5	8.4	0.1
TSPI-0412-R47M	LF	0.47	19	22	6.0	6.8	0.1
TSPI-0412-R68M	LF	0.68	32	36	4.7	6.0	0.1
TSPI-0412-1R0M	LF	1.0	43	47	4.5	5.5	0.1
TSPI-0412-1R5M	LF	1.5	68	75	3.25	4.0	0.1
TSPI-0412-2R2M	LF	2.2	79.4	83.5	2.75	3.5	0.1
TSPI-0412-4R7M	LF	4.7	170	195	1.80	2.8	0.1

- ◆ Typical Heat Rating Current (Idc) ▸ would cause an approximate ΔT of 40°C
- ◆ Typical Saturation Current (Isat) ▸ would cause (Lo) to drop approximately 30%

I Performance Curve

| Performance Curve

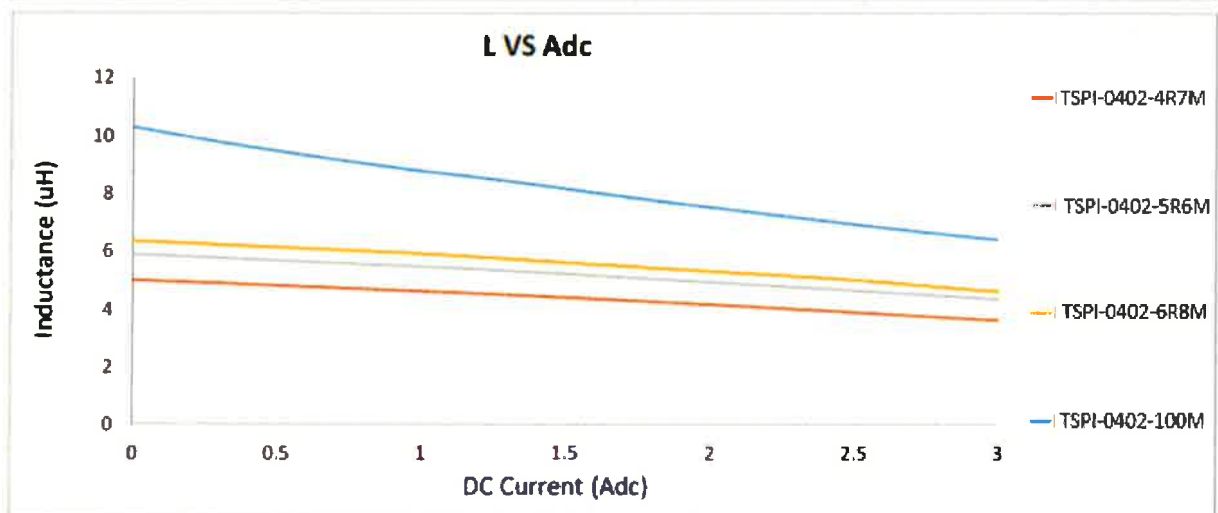
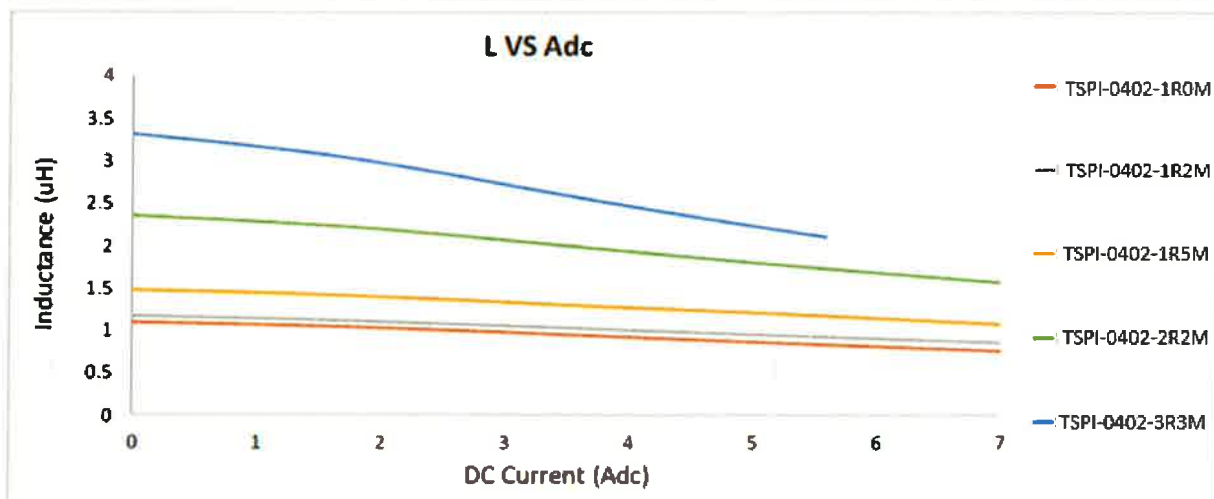
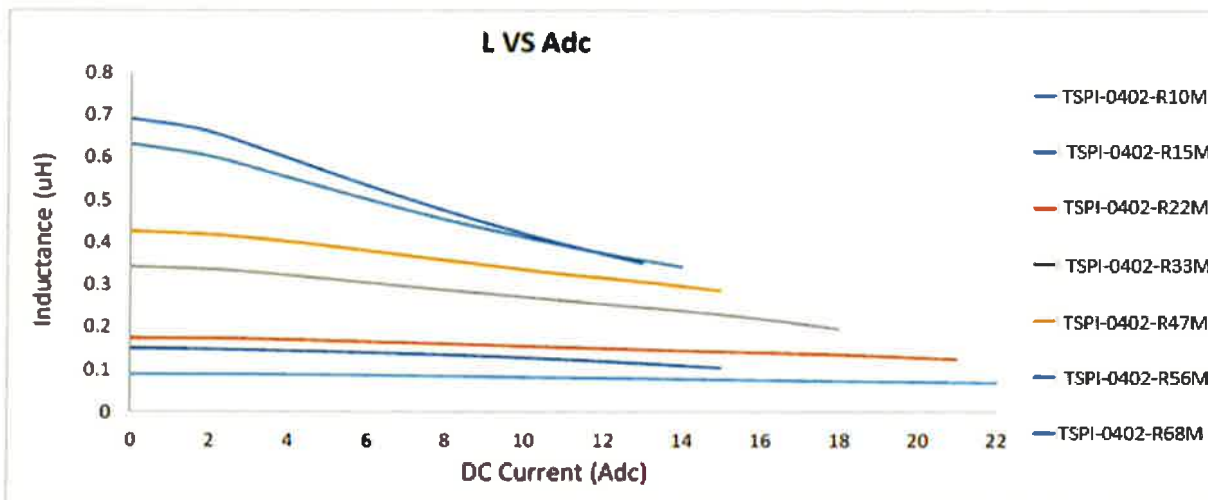

I Performance Curve

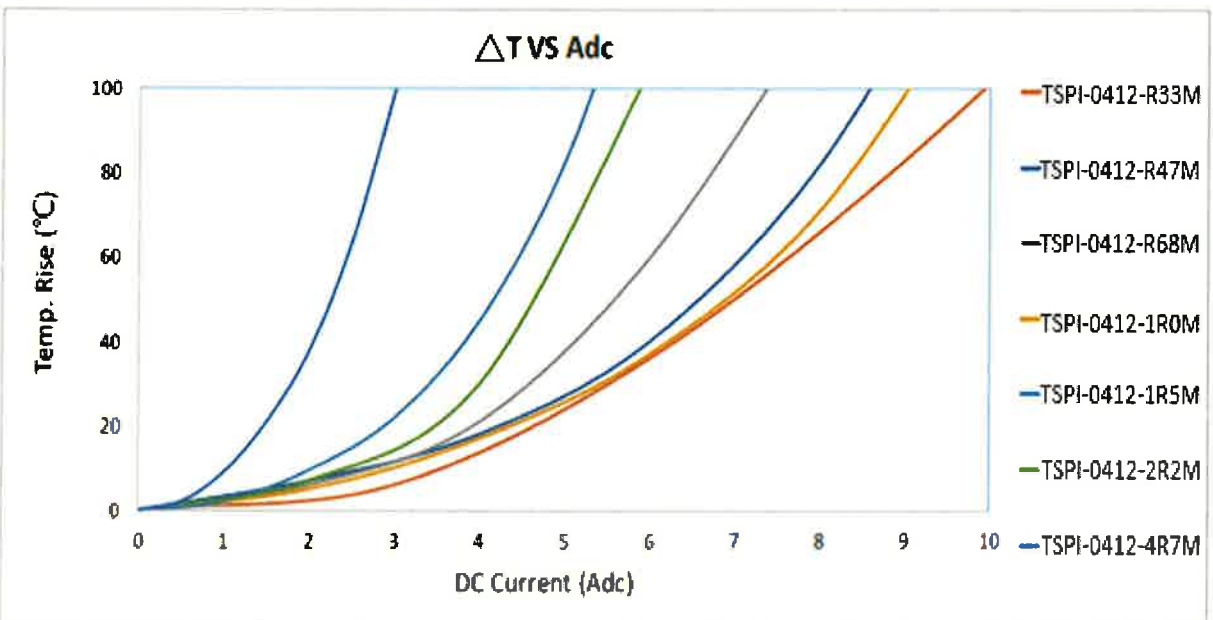
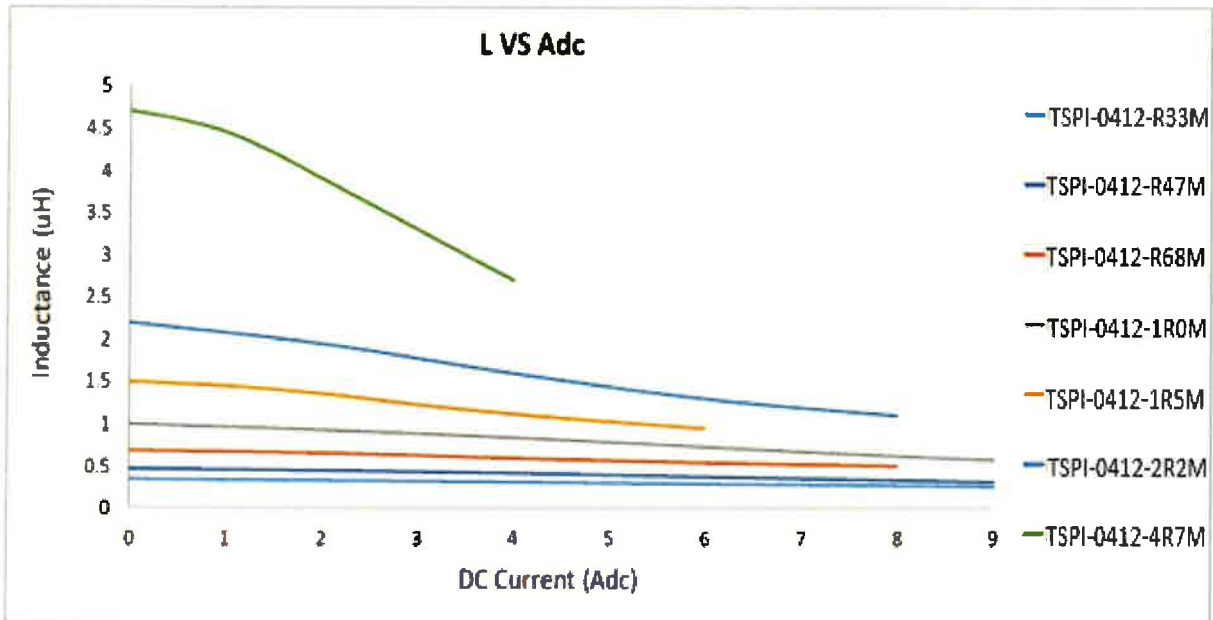

J General Information

- (J1) Testing Condition
25 °C , 60 % RH
- (J2) Operating Temperature
-55 °C ~ 125 °C
- (J3) Storage Condition
25 °C ~ 35 °C , < 70 % RH
- (J4) Moisture Sensitive Level Class
MSL > 1
- (J5) The Part temperature should not exceed 125°C under worst case operating condition.
Part temperature should be checked and verified by the application developer(s) as the performance of the part might be affected.

K Reliability tests and referred standards**(K1) Electrical Performance Test**

- Spec ▶ Inductance : As listed in table "H" @ 100kHz/1.0V
- Tester ▶ WK3260B,HP4284A,CH3302
- Spec ▶ DCR : As listed in table "H" @ 25°C
- Tester ▶ CH16502 Micro-Ohm Meter
- Spec ▶ Isat : As listed in table "H"
- Tester ▶ WK3260B/WK3265B(BIAS)
- Spec ▶ I_{dc} : As listed in table "H"
- Tester ▶ WK3260B/WK3265B(BIAS)

(K2) Low Temperature Exposure (Storage)

- Spec ▶ Inductance change within 20% without mechanical damage.
- Method ▶ JESD22-A119 - Condition "B"
- Setting : Store at -55°C -10/+0°C.
- Duration : 1000 ± 4 Hours.

(K3) High Temperature Exposure (Storage)

- Spec ▶ Inductance change within 20% without mechanical damage.
- Method ▶ MIL-STD-202G - Method "108A" / Condition "D"
- Setting : Store at 125°C ± 3°C.
- Duration : 1000 ± 4 Hours.

(K4) Temperature Cycling

- Spec ▶ Inductance change within 20% without mechanical damage.
- Method ▶ JESD22 - Method "JA-104" / Condition "H"
- ▶ Cycling : -55°C(keep 30min) ▶ Transition Period(≤10 minute) ▶ 125°C
125°C(keep 30min) ▶ Transition Period(≤10 minute) ▶ -55°C
- Duration : 1000 cycles.

(K5) Biased Humidity

- Spec ▶ Inductance change within 20% without mechanical damage.
- Method ▶ MIL-STD-202G - Method "103"
- Setting : 85°C / 85% RH Chamber with unpowered inductors.
- Duration : 1000 ± 4 Hours.

(K6) Operational Life

- Spec ▶ Inductance change within 20% without mechanical damage.
- Method ▶ MIL-STD-202G - Method "108A" / Condition "D"
- Setting : Apply I_{dc} current with elevated ambient to make 125°C
- Duration : 1000 ± 4 Hours.

(K7) Physical Dimension

- Spec ▶ Refer to page 2, item "C Dimensions"
- Method ▶ JESD22 - Method "JB-100"
- Sample Size : 30 pcs

(K8) Terminal Strength (SMD)

- Spec ▶ Inductance change within 20% without mechanical damage.
- Method ▶ ACE-Q200 - Method "006"
- Setting : Mounted to PCB and apply 17.7N or 1.8kg force
- Duration : 60 + 1 Second.

K Reliability tests and referred standards

(K9) Mechanical Shock:

- Spec ▶ Inductance change within 20% without mechanical damage.
- Method ▶ MIL-STD-202G - Method "213" / Condition "C"
 - Peak force : 100G
 - Direction : Shocks in each direction along 3 perpendicular axes.

(K10) Vibration:

- Spec ▶ Inductance change within 20% without mechanical damage.
- Method ▶ MIL-STD-202G - Method "201"
 - Frequency : 10Hz~55Hz~10Hz , 1 minute cycle.
 - Duration : Approximatly 2 hours.

(K11) Resistance to Soldering Heat:

- Spec ▶ Inductance change within 20% without mechanical damage.
- Method ▶ MIL-STD-202G - Method "210" / Condition "J"
 - Setting : Reflow Peak $235 \pm 5^{\circ}\text{C}$ ($30 \pm 5\text{s}$) / Time above 183°C (90~120s)
 - Heat Cycles : 3

(K12) Solderability

- Spec ▶ The surface of terminals tested shall be covered with new solder by 95%.
- Method ▶ J-STD-002D - Precondition "Category B" / Testing parameter "Table B1"
 - Preheating : $150 \pm 10^{\circ}\text{C}$ 60 seconds
 - Soldering : $245 \pm 5^{\circ}\text{C}$ for 5 +0/-0.5 seconds

(K13) Board Flex:

- Spec ▶ Inductance change within 20% without mechanical damage.
- Method ▶ ACE-Q200 - Method "005"
 - Setting : 2mm minimum downward displacement of PCB board.
 - Duration : 60 + 5 Seconds.

⌊ Packing Information :

(L1) Reel Dimensions

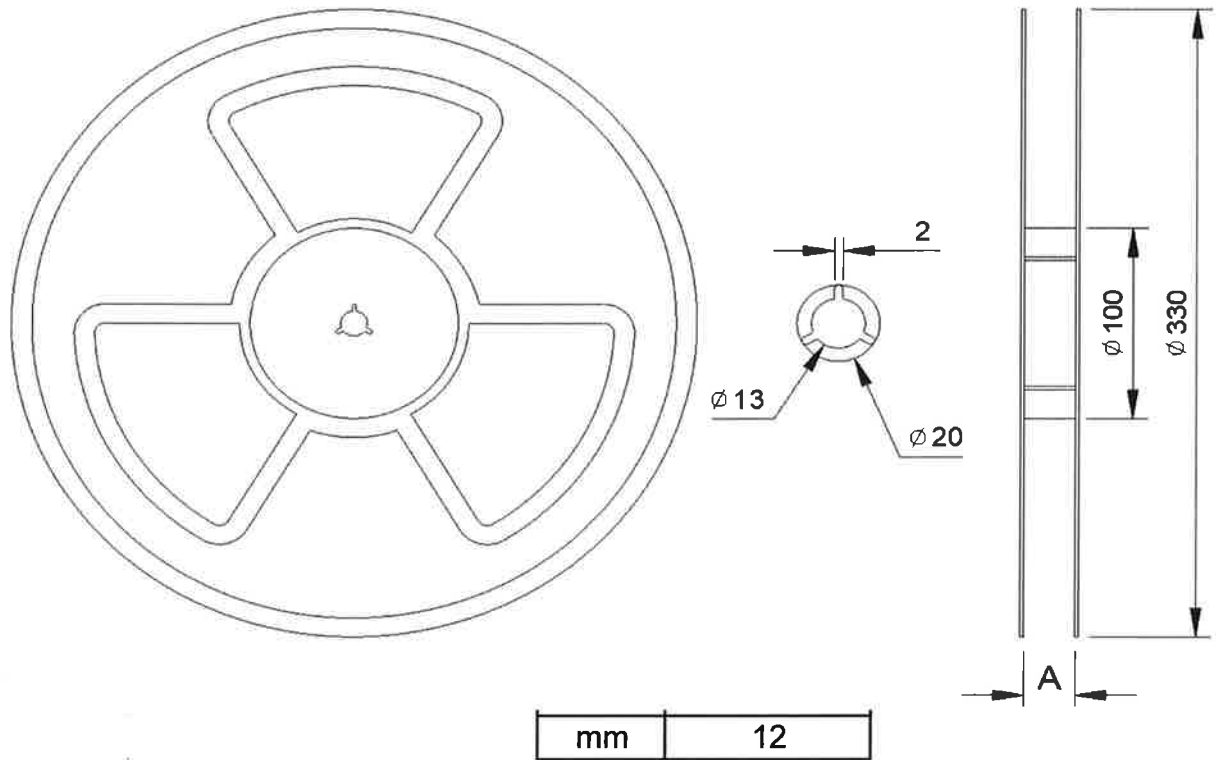

(L2) Carrier Tape Dimensions

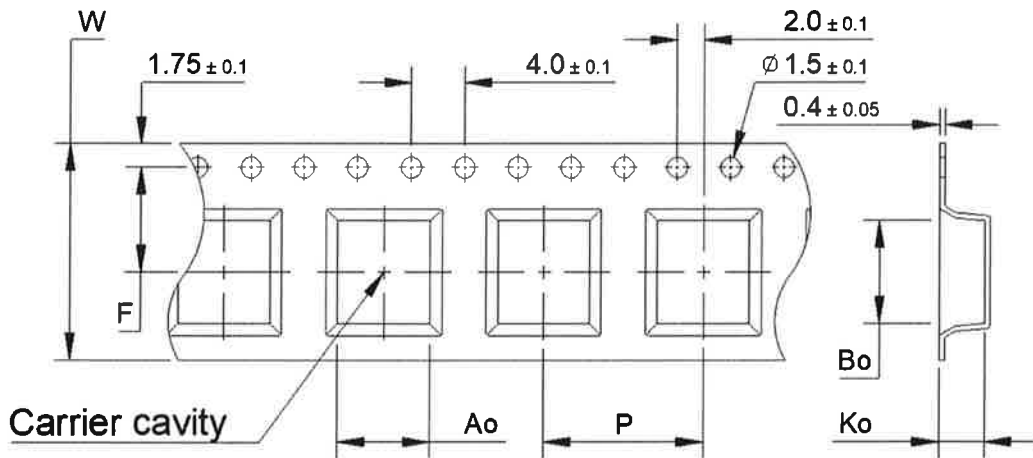

	Ao	Bo	Ko	F	P	W
mm	4.6 ± 0.1	4.75 ± 0.1	1.4 ± 0.1	5.5 ± 0.1	8.0 ± 0.1	12.0 ± 0.3

	Lead-OUT (Leader)	Packing Quantity	Lead-IN (Trailer)
cavity	> 400mm	3000 PCS	> 180mm

L Packing Information :

(L3) Taping Direction

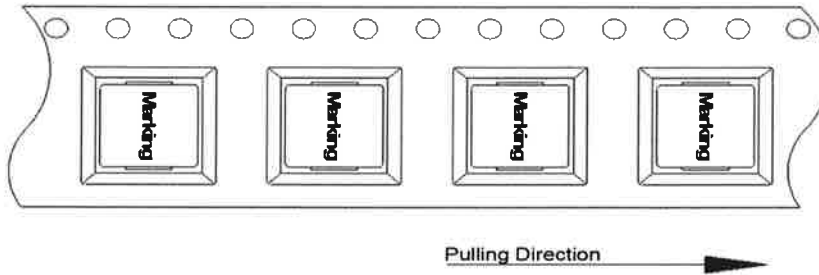

(L4) Peel Force of Top Covering Tape

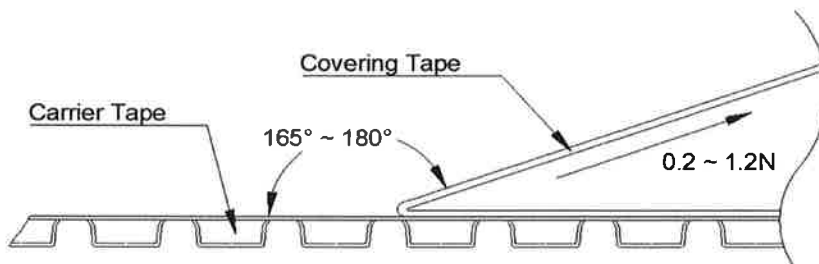

(L5) Packing Quantity

6 / Six Reels / Carton

3000 / 3.00k Pieces / Reel

18000 / 18.00k Pieces / Carton

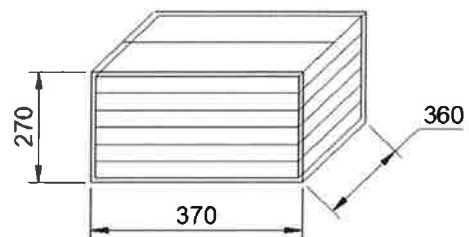
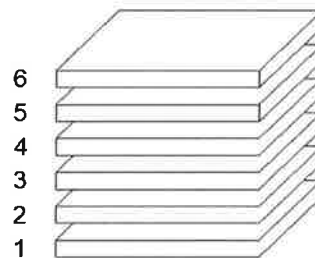

M Soldering Specifications :

(M1) Classification Reflow Profile for SMT Components

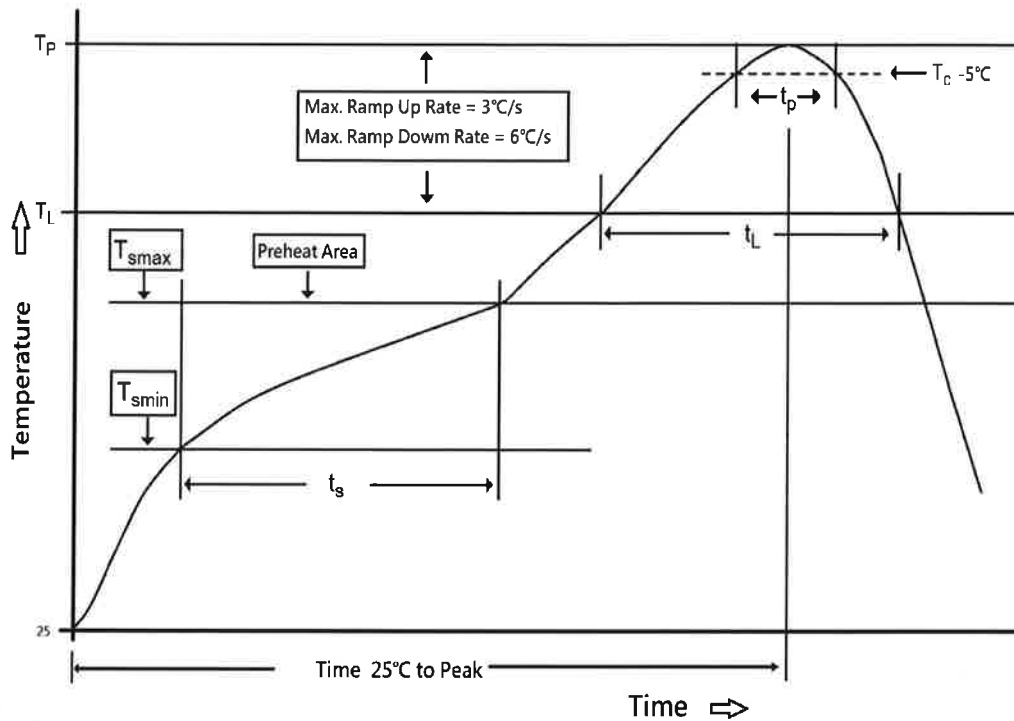

Profile Feature	Pb-Free Assembly
Preheat	
- Temperature Min(T_{smin})	150°C
- Temperature Max(T_{smax})	200°C
- Time (t_s) from (T_{smin} to T_{smax})	60-120 seconds
Ramp-up rate (T_L to T_p)	3°C/ second max.
Liquidous temperature(T_L)	217°C
Time (t_L) maintained above T_L	60-150 seconds
Peak package body temperature(T_p)	See Table M3
Time within 5°C of actual peak temperature (t_p)	20-30 seconds
Ramp-down rate (T_p to T_L)	6°C/ second max.
Time 25°C to peak temperature	8 minutes max.
Number of Reflow cycles allowed	2 cycles max.

refer to J-STD-020D

(M3) Package Classification Reflow Temperature

	Package Thickness	Volume mm ³	Volume mm ³	Volume mm ³
		<350	350 - 2000	>2000
PB-Free Assembly	< 1.6mm	260°C	260°C	260°C
PB-Free Assembly	1.6-2.5mm	260°C	250°C	245°C
PB-Free Assembly	≥ 2.5mm	250°C	245°C	245°C

refer to J-STD-020D

N Material Breakdown and Listing :

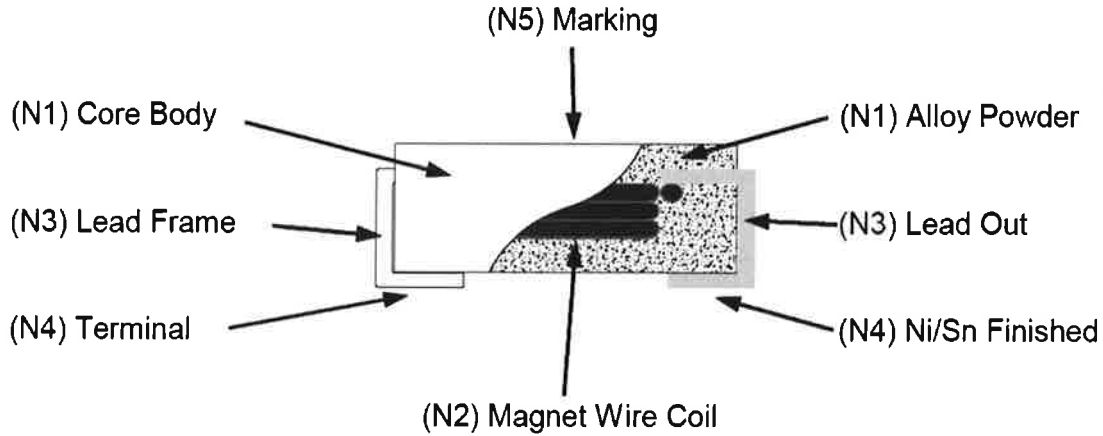

No.	ITEM	MATERIAL DESCRIPTION	SOURCE	UL
N1	Core Body	Alloy Powder / FeSiCr	AVEN	N/A
N2	Magnet Wire	Polyamide-imide enameled Cu Wire / AIW	PEWC	E201757
N3	Lead Frame	Copper Lead Frame	CHIEF	N/A
N4	Terminal	Dual-layer Plating / Sn over Ni	CHIEF	N/A
N5	Marking	Ketone based black ink	M. IMAJE	N/A

O Care Note :

(O1) Carton Handling :

Shipping by carton(s) without a pallet is allowed if handled with care.

Points below **MUST** be enforced for carton handling:

1. Cartons are NOT to be placed in up-side-down position at all time.
2. Cartons are NOT to be placed in vertical position at all time.
3. Cartons are to be handled by hand only, any damage on carton may affect the integrity of components held inside.
4. Inspection of components is required upon carton deformation.
5. Carton(s) **MUST NOT** be exposed under direct sun light for storage.

Stacking of cartons is allowed but deformation of carton shall be avoid.

(O2) Washing Detergent :

All cleaning agent including pure water may compromise the integrity of the component(s), Please get confirmation before any use of washing detergent.

(O3) Extra Infomation :

Please contact authorized distributor for additional information that is not listed in this document.