

ITEM P/N	PCM4532A-SERIES	TEST INSTRUMENT	Agilent4291B / Agilent4338B
PRODUCT	COMMON MODE CHOKE	TEST FREQUENCY	100 MHz / 0.5V

PACKING DIMENSIONS (mm)

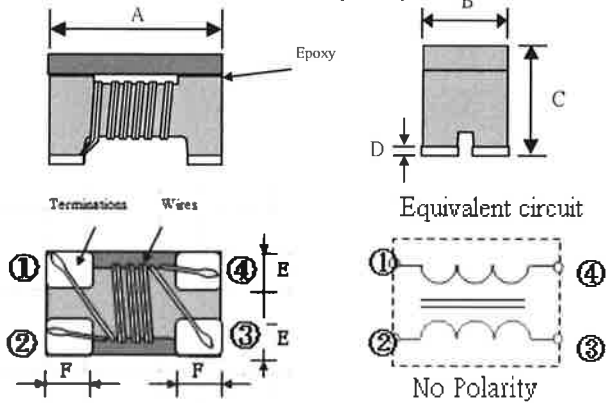

4532	Dimensions
A	4.5 ± 0.2
B	3.2 ± 0.2
C	2.8 ± 0.2
D	0.2 ± 0.1
E	1.2Typ.
F	1.0Typ.

EXPLANATION OF PART NUMBERS

1	2	3	4	5	6	7	8	9	10	11	
P	C	M	4	5	3	2	-	1	0	2	S
	(1)			(2)				(3)		(4)	

- (1) Product name
 (2) Shapes and dimensions
 (3) Impedance 【 at 100MHz 】
 102:1000Ω
 (4) Tolerance
 S=±25% ; M=±20%

ELECTRICAL CHARACTERISTICS

P/N	Z(Ω)	DCR (Ω)	Rated current	Rated Voltage	Insulation Resistance
	Common Mode				
	Impedance	[Max]	Idc(A)	Vdc	IR
	at 100MHz		[Max]	(V)Typical	(MΩ)Min.
PCM4532A-800S	80	0.07	3	50	10
PCM4532A-121S	120	0.07	3	50	10
PCM4532A-201S	200	0.10	2	50	10
PCM4532A-601S	600	0.30	1.5	50	10
PCM4532A-801S	800	0.35	1	50	10
PCM4532A-102S	1000	0.40	1	50	10

Operating temperature : -25 to +85°C

Storage temp. and humidity : -40 to +85°C ,70%RH max

Typical Heat Rating DC Current would cause an approximately ΔT of 40°C

If Use Wave soldering is there will be some risk. Re-flow soldering temperatures below 240 degrees, there will be unwitting risk

CHARACTERISTICS

**RoHS
COMPLIANT**

ITEM P/N	PCM4532A-SERIES	TEST INSTRUMENT	Agilent4291B / Agilent4338B
PRODUCT	COMMON MODE CHOKE	TEST FREQUENCY	100 MHz / 0.5V

PERFORMANCE CURVES

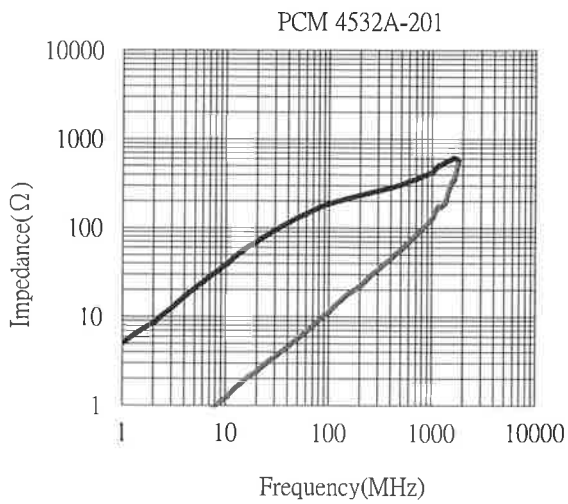
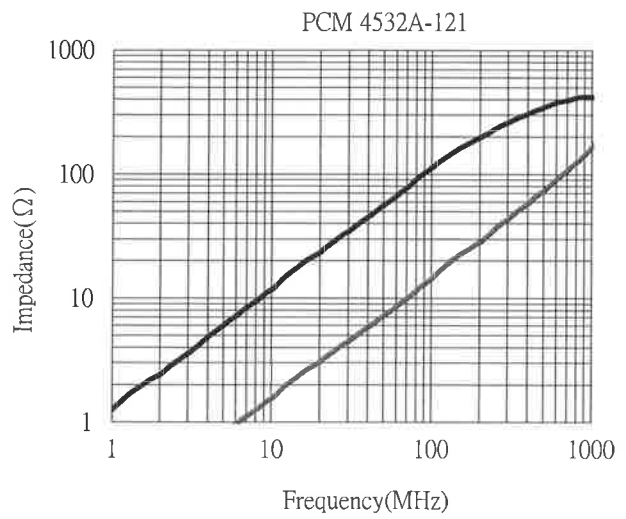
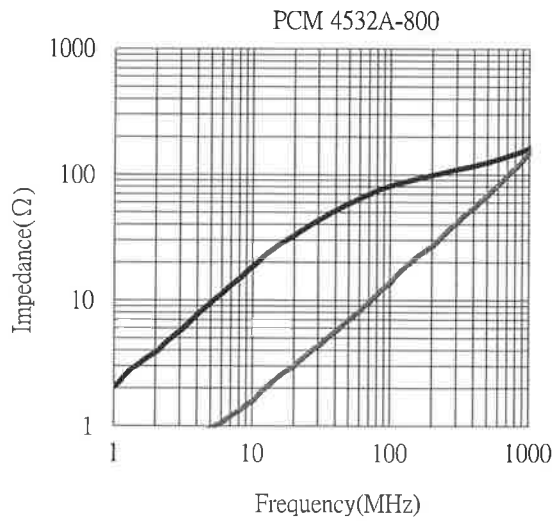

Recommended Footprint(mm)

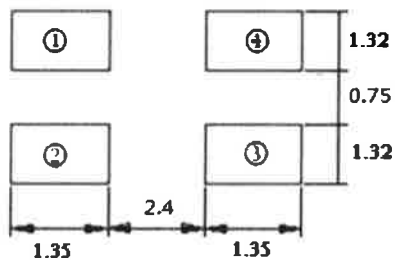
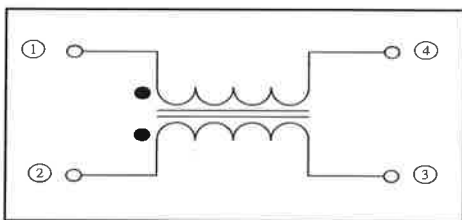

ITEM P/N	PCM4532A-SERIES	TEST INSTRUMENT	Agilent4291B / Agilent4338B
PRODUCT	COMMON MODE CHOKE	TEST FREQUENCY	100 MHz / 0.5V

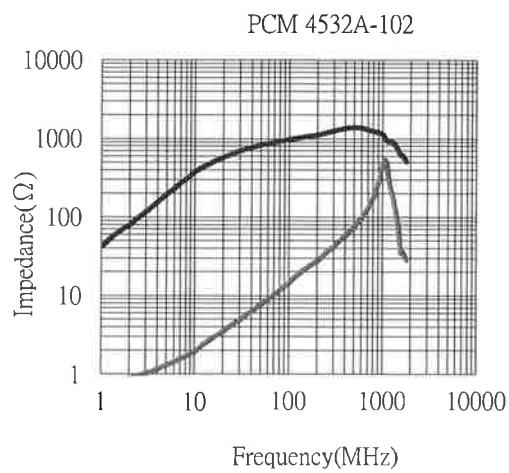
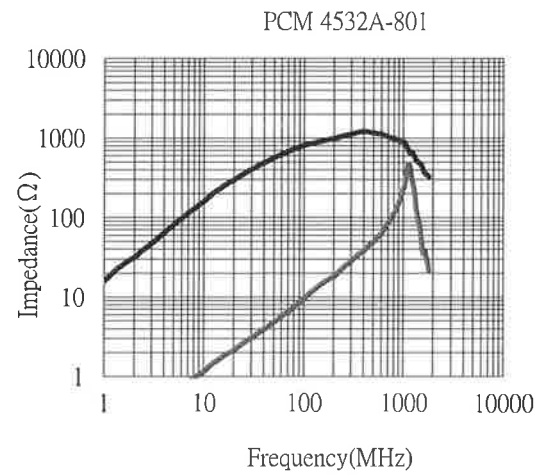
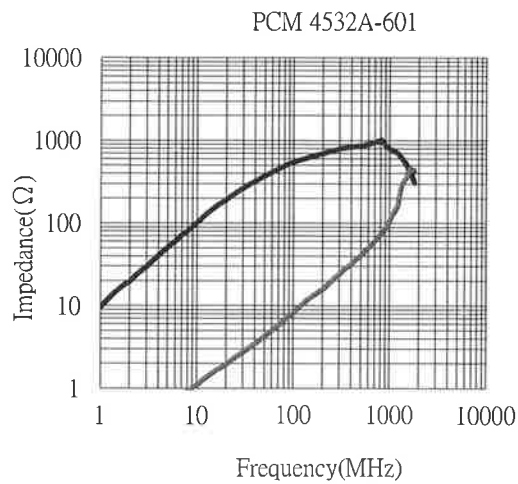
PERFORMANCE CURVES

ITEM P/N	PCM4532A-SERIES	TEST INSTRUMENT	Agilent4291B / Agilent4338B
PRODUCT	COMMON MODE CHOKE	TEST FREQUENCY	100 MHz / 0.5V

Test Equipment**Impedance**

Measured by using Agilent 4291B RF Impedance Analyzer.

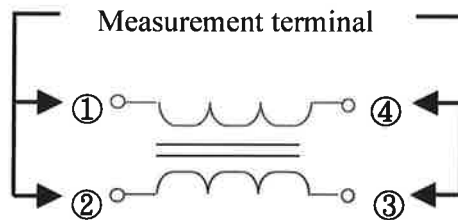
**DC Resistance**

Measurement terminal

Measured by using Agilent4338B mill ohm meter.

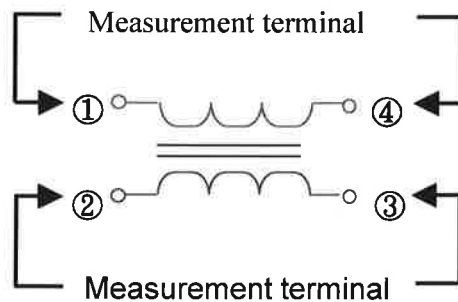
**Insulation Resistance**

Measured by using Chroma 19073

Measurement voltage : 50v ,Measurement time : 60 sec.

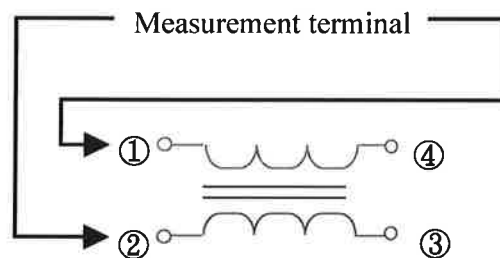

ITEM P/N	PCM4532A-SERIES	TEST INSTRUMENT	Agilent4291B / Agilent4338B
PRODUCT	COMMON MODE CHOKE	TEST FREQUENCY	100 MHz / 0.5V

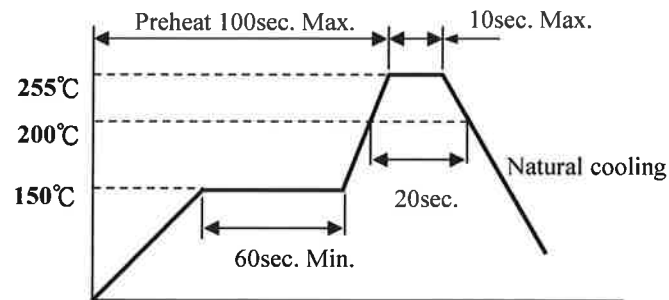
RECOMMENDED SOLDERING TEMP. GRAPH**MECHANICAL RELIABILITY**

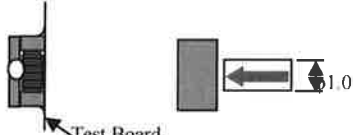
TEST	Specification & Requirement	Method Used
Solderability	The surface of terminal/pin tested shall be covered with new solder by 90%	Solder heat proof: Preheating: 150 ±10°C 60 seconds Soldering: 245 ±5°C for 4 ±1 sec
Solder Heat Resistance	Components should have not evidence of electrical and mechanical damage Impedance: within ±15% of initial value	Preheating: 150°C 60secs Solder temperature: 260±5°C Flux: rosin Dip time: 10±0.5 secs
Terminal strength	Series No.	F (Kg)
	1608	0.5
	2012	0.5
	3216	1.0
	3225	1.0
		Solder a chip to test substrate and then laterally apply a force in the arrow direction 

ENDURANCE RELIABILITY

TEST	Specification & Requirement	Method Used
Thermal Shock	Impedance change within ± 15% Without mechanical damage	-65°C, (30 mins) -> room temp. (2 mins) -> 125°C, (30 mins) -> room temp. (2 mins) 50 cycles
Humidity Resistance	Impedance change within ± 15% Without mechanical damage	Apply IDC current @ 60°C ambient Humidity: 90% Duration: 168 hrs
Low Temp. Storing	Impedance change within ± 15% Without mechanical damage	Storing Temp. -40 ±2 °C for total 168 +5/-0 hours
High Temp. Storing	Impedance change within ± 15% Without mechanical damage	Storing Temp. 125 ±2 °C for total 168 +5/-0 hours

ITEM P/N	PCM4532A-SERIES	TEST INSTRUMENT	Agilent4291B / Agilent4338B
PRODUCT	COMMON MODE CHOKE	TEST FREQUENCY	100 MHz / 0.5V

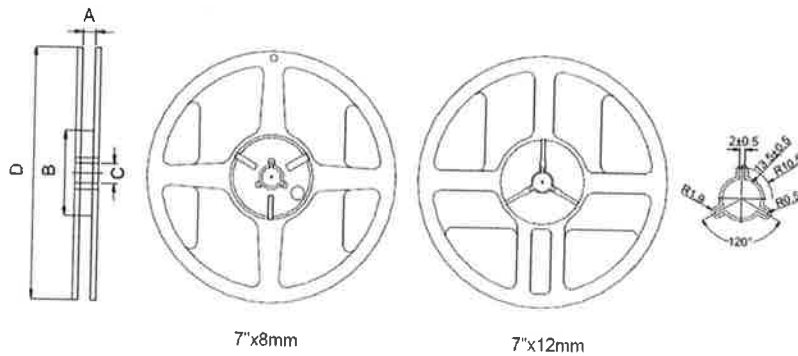
Reel Dimension & Tape Dimension

Type	A(mm)	B(mm)	C(mm)	D(mm)
7"x8mm	9.0±0.5	60±2	13.5±0.5	178±2
7"x12mm	13.5±0.5	60±2	13.5±0.5	178±2

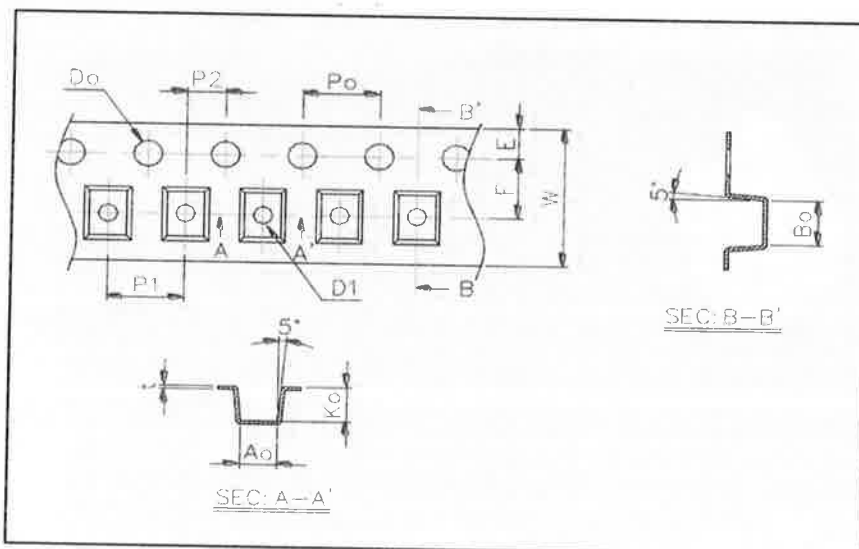

Size	Ao(mm)	Bo(mm)	Ko(mm)	W(mm)	E(mm)	F(mm)	Po(mm)	P1(mm)	Do(mm)
1608	1.00±0.10	1.65±0.10	1.18±0.10	8.00±0.20	1.75±0.10	3.50±0.05	4.0±0.05	4.0±0.10	none
2012	1.50±0.10	2.35±0.10	1.45±0.10	8.00±0.20	1.75±0.10	3.50±0.05	4.0±0.05	4.0±0.10	1.0±0.1
3216	1.88±0.10	3.50±0.10	2.10±0.10	8.00±0.20	1.75±0.10	3.50±0.05	4.0±0.05	4.0±0.10	1.0±0.1
4532	4.90±0.10	3.45±0.10	3.05±0.10	12.00±0.20	1.75±0.10	5.50±0.05	4.0±0.05	8.0±0.10	1.5±0.1,-0

Packaging Quantity

Chip Size	1608	2012	3216	4532
8mm/ Reel	2000	2000	2000	500